

Precision Photonics

Cutting Edge Engineering at the Speed of Light



Compact Semiconductor IR Laser

AIMPICO compact diode laser systems deliver stable, high-quality coherent output across ultraviolet, visible, and near-infrared wavelengths — engineered for laboratory, clinical, and OEM environments where wavelength accuracy, power stability, and long-term reliability are essential.

Built on direct-emission semiconductor technology, AIMPICO lasers require no optical pumping, harmonic conversion, or consumables, offering exceptional wall-plug efficiency and a significantly simplified thermal footprint compared to gas or lamp-pumped alternatives. The laser source, drive electronics, and thermal management are integrated into a single compact platform, with active closed-loop stabilization maintaining output power within $\pm 1\%$ RMS across the full operating temperature range.



Applications

- Flow cytometry
- Medical imaging
- Fluorescence microscopy
- DNA sequencing

Key Feature Highlights

• Compact, Integration-Ready Design	Fits standard optical breadboards and cage systems; Compact design enables direct drop-in to instrument assemblies
• Stable Output ($\pm 1\%$ RMS)	Active closed-loop control ensures consistent power across the full operating range
• 30 kHz TTL/Analog Modulation	Hardware-level synchronization with cameras, lock-in amplifiers, and instrument timing systems
• Efficient Thermal Management	Low thermal load and passive heat dissipation reduce the need for active cooling, simplifying optical table layouts
• Long Operational Lifetime	Semiconductor gain medium with no consumables, no gas fill, and no electrodes — operate without scheduled maintenance interventions



Technical Specification

OPTICAL PARAMETERS

Center Wavelength	980 nm ± 10 nm
Operating Mode	Continuous Wave
Output Power	1 – 2,500 mW
Power Stability (rms, 4 hours±3°C)	< 1%
Transverse Mode	Multimode
Beam Divergence (full angle)	< 3.0 mrad
Beam Diameter at the aperture (1/e ²)	~ 5.0 mm x 8.0 mm

ELECTRICAL PARAMETERS

Compatible Power Supply (100-240VAC)	LPS-I/LPS-II/LPS-III/LPS-OEM-I
Modulation Options	DC-1kHz, 1kHz-10kHz, 10kHz-30kHz, 30kHz-100kHz optional, TTL/Analog optional

MECHANICAL PARAMETERS

Dimensions	146(L) × 73(W) × 46.2(H) mm ³
Weight	0.7 kg
Cooling Method	Conduction
Beam Height from Base Plate	24.8 mm

ENVIRONMENTAL

Operating Temperature	10 – 35 °C
Laser Warmup Time	< 5 min
Expected Lifetime	> 10,000 hours

Mechanical Drawings

Laser Head

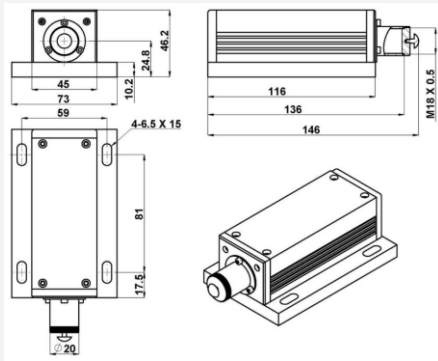

146(L) × 73(W) × 46.2(H) mm³, 0.7kg

Compatible Power Supply (LPS-I¹)

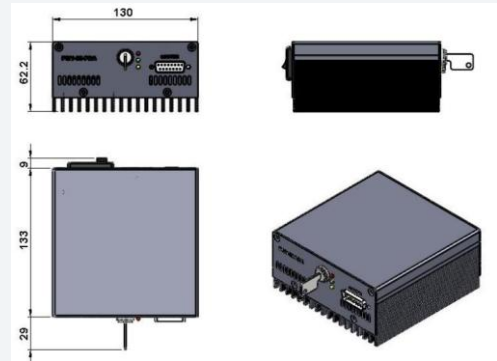

171(L) × 130(W) × 62.2(H) mm³, 1.2kg

Compatible Power Supply (LPS-II²)

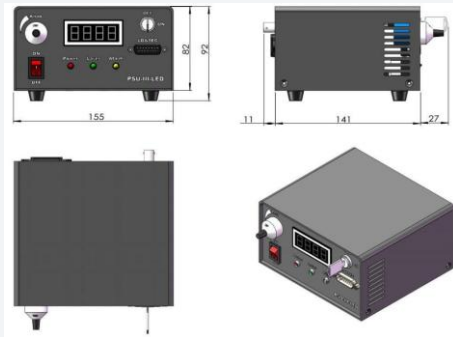

179(L) × 155(W) × 92(H) mm³, 1.5kg

Compatible Power Supply (LPS-III³)



162(L) × 144(W) × 70(H) mm³, 1.0kg

Compatible Power Supply (LPS-OEM-I¹)

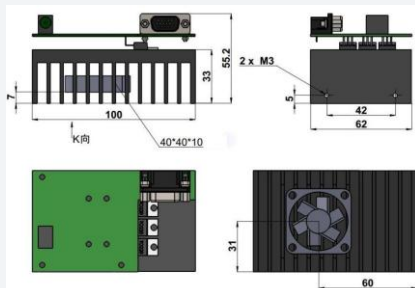

100(L) × 62(W) × 55.2(H) mm³, 0.5kg

Product Certifications



1,2,3: Sold separately.

1: Fixed output power, modulation frequency up to 30kHz.

2: Output power adjustable 10-100%; modulation frequency up to 30kHz.

3: Output power adjustable 10-100%; modulation frequency up to 100kHz.



Toronto, ON, Canada



sales@aimpico.com